

Yearly Team Meeting

Thursday, 18th October 2013

Claudio Fiandrino, claudio.fiandrino@uni.lu

SnT, Université du Luxembourg

- ▶ Computer and Communication Networks Engineering in Politecnico of Torino
 - ▶ Bachelor Degree on September 20th, 2010
 - ▶ Master Degree on November 30th, 2012

- ▶ Started the PhD on May 15th, 2013
 - ▶ Dzmitry Kliazovich
 - ▶ Pascal Bouvry

1 Performance Metrics for Communication Systems

2 Network Coding

3 Application Defined Networks

- ▶ Existing metrics do not capture performances of data center communication systems
- ▶ We propose new metrics which are able to
 - ▶ find area of improvement in current data center network
 - ▶ compare the performances of different data center networks

- ▶ Existing metrics do not capture performances of data center communication systems
- ▶ We propose new metrics which are able to
 - ▶ find area of improvement in current data center network
 - ▶ compare the performances of different data center networks

- ▶ Power
 - ▶ Communication Network Power Efficiency
 - ▶ Network Power Usage Effectiveness
- ▶ Performance
 - ▶ Average Uplink/Downlink Communication Latency
 - ▶ Average Packet Loss Ratio
- ▶ Network traffic
 - ▶ Internal Traffic Ratio
 - ▶ Operational Traffic Ratio

- ▶ Power
 - ▶ Communication Network Power Efficiency
 - ▶ Network Power Usage Effectiveness
- ▶ Performance
 - ▶ Average Uplink/Downlink Communication Latency
 - ▶ Average Packet Loss Ratio
- ▶ Network traffic
 - ▶ Internal Traffic Ratio
 - ▶ Operational Traffic Ratio

- ▶ Power
 - ▶ Communication Network Power Efficiency
 - ▶ Network Power Usage Effectiveness
- ▶ Performance
 - ▶ Average Uplink/Downlink Communication Latency
 - ▶ Average Packet Loss Ratio
- ▶ Network traffic
 - ▶ Internal Traffic Ratio
 - ▶ Operational Traffic Ratio

1 Performance Metrics for Communication Systems

2 Network Coding

3 Application Defined Networks

- ▶ Reference example:

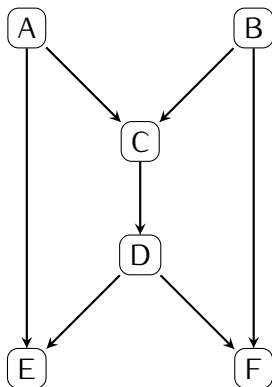

- ▶ Reference example:

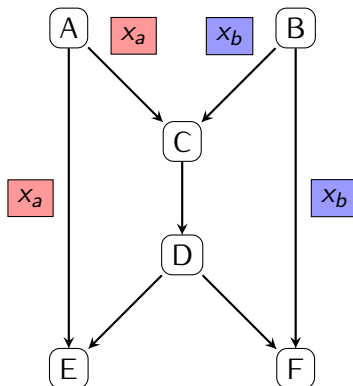

- ▶ Reference example:

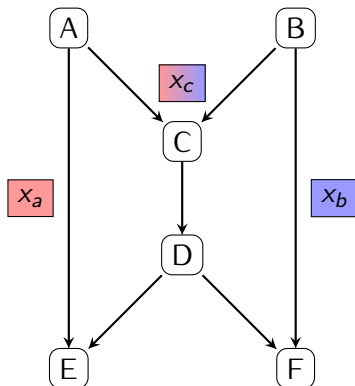

$$x_c = x_a \oplus x_b$$

- ▶ Reference example:

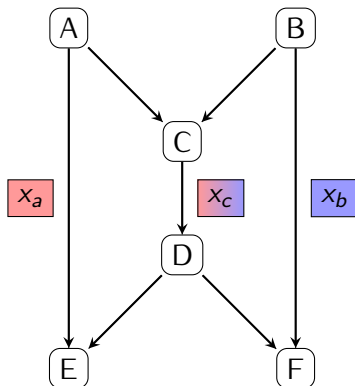

$$x_c = x_a \oplus x_b$$

- ▶ Reference example:

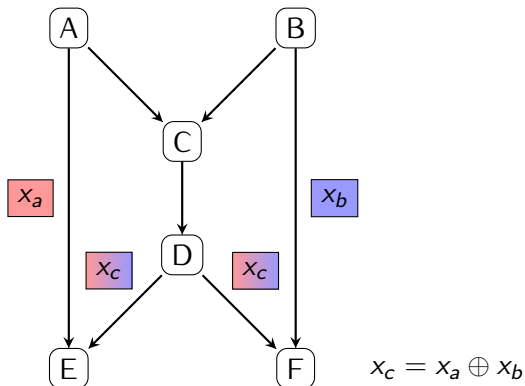

- ▶ Reference example:

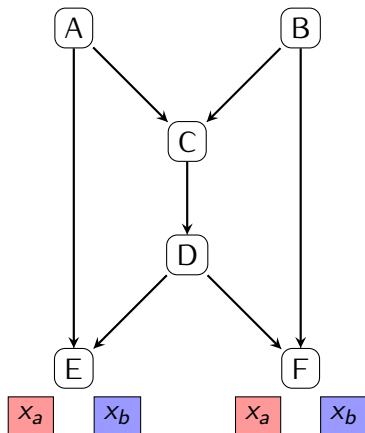

Our approach

- ▶ Local optional traffic
- ▶ Cache
- ▶ Appropriate scheduling

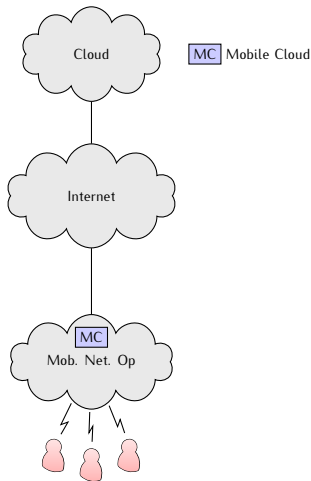

1 Performance Metrics for Communication Systems

2 Network Coding

3 Application Defined Networks

Application Defined Networks

Introduction

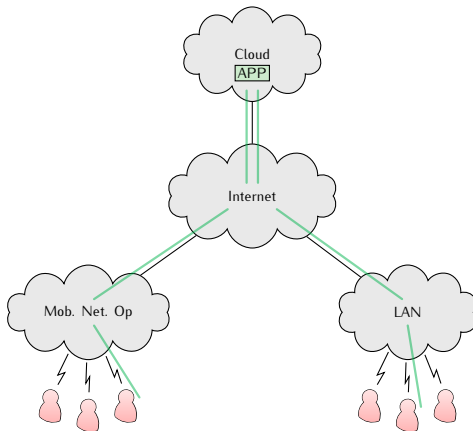

Application Defined Networks

Related concepts

- ▶ Software-Defined Networks (SDN)
- ▶ Application-Aware Networks (AAN)



```
\begin{center}  
  \smartdiagramanimated  
  [bubble diagram]  
  {  
    Packages,  
    Engtlc,  
    Beamer2Thesis,  
    Dynblocks,  
    hf-tikz,  
    smartdiagram,  
    sa-tikz  
  }  
\end{center}
```

- ▶ Originated from: [PowerPoint's "Smart Art" for TikZ?](#) in T_EX.SX

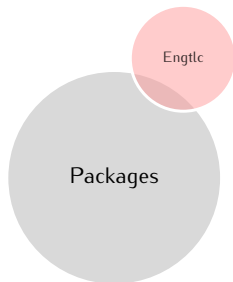

```
\begin{center}
\smartdiagramanimated
[bubble diagram]
{
  Packages,
  Engtlc,
  Beamer2Thesis,
  Dynblocks,
  hf-tikz,
  smartdiagram,
  sa-tikz
}
\end{center}
```

- ▶ Originated from: [PowerPoint's "Smart Art" for TikZ?](#) in T_EX.SX

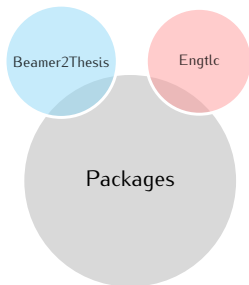

```
\begin{center}
\smartdiagramanimated
[bubble diagram]
{
  Packages,
  Engtlc,
  Beamer2Thesis,
  Dynblocks,
  hf-tikz,
  smartdiagram,
  sa-tikz
}
\end{center}
```

- ▶ Originated from: [PowerPoint's "Smart Art" for TikZ?](#) in T_EX.SX

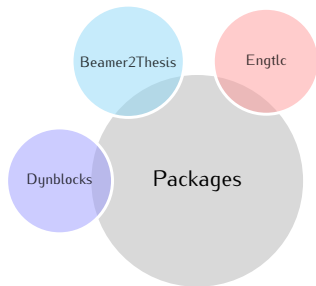

```
\begin{center}
\smartdiagramanimated
[bubble diagram]
{
  Packages,
  Engtlc,
  Beamer2Thesis,
  Dynblocks,
  hf-tikz,
  smartdiagram,
  sa-tikz
}
\end{center}
```

- ▶ Originated from: [PowerPoint's "Smart Art" for TikZ?](#) in T_EX.SX

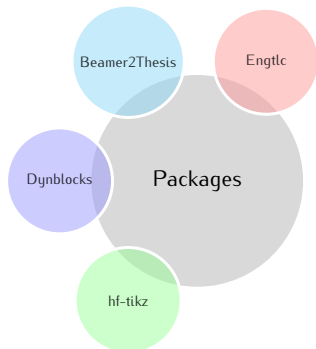

```
\begin{center}
\smartdiagramanimated
[bubble diagram]
{
  Packages,
  Engtlc,
  Beamer2Thesis,
  Dynblocks,
  hf-tikz,
  smartdiagram,
  sa-tikz
}
\end{center}
```

- ▶ Originated from: [PowerPoint's "Smart Art" for TikZ?](#) in T_EX.SX

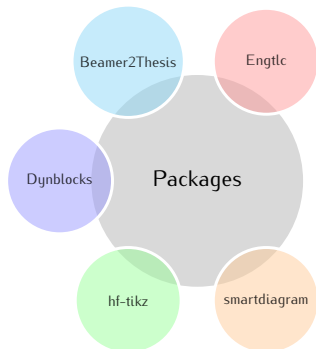

```
\begin{center}
\smartdiagramanimated
[bubble diagram]
{
  Packages,
  Engtlc,
  Beamer2Thesis,
  Dynblocks,
  hf-tikz,
  smartdiagram,
  sa-tikz
}
\end{center}
```

- ▶ Originated from: [PowerPoint's "Smart Art" for TikZ?](#) in T_EX.SX



```
\begin{center}
\smartdiagramanimated
[bubble diagram]
{
  Packages,
  Engtlc,
  Beamer2Thesis,
  Dynblocks,
  hf-tikz,
  smartdiagram,
  sa-tikz
}
\end{center}
```

- ▶ Originated from: [PowerPoint's "Smart Art" for TikZ?](#) in T_EX.SX



```
\begin{center}
\smartdiagramanimated
[bubble diagram]
{
  Packages,
  Engtlc,
  Beamer2Thesis,
  Dynblocks,
  hf-tikz,
  smartdiagram,
  sa-tikz
}
\end{center}
```

► Originated from: [PowerPoint's "Smart Art" for TikZ?](#) in T_EX.SX

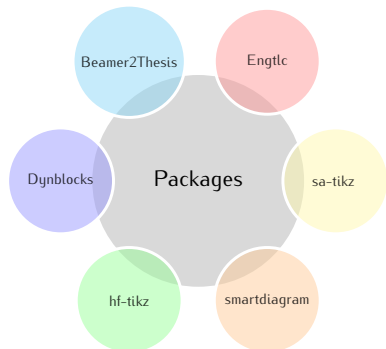

```
\begin{center}
\smartdiagramanimated
[bubble diagram]
{
  Packages,
  Engtlc,
  Beamer2Thesis,
  Dynblocks,
  hf-tikz,
  smartdiagram,
  sa-tikz
}
\end{center}
```

- ▶ Originated from: [PowerPoint's "Smart Art" for TikZ?](#) in T_EX.SX

Benes Network

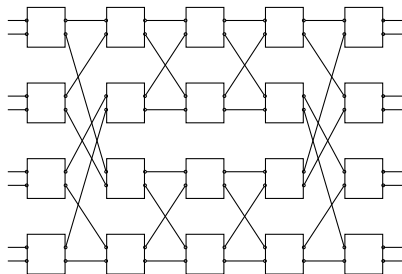

```

\begin{tikzpicture}
  \node[P=8,benes complete={
    module label opacity=0
  }
  ]{};
\end{tikzpicture}
  
```

- ▶ Claudio Fiandrino. Sa-TikZ: a library to draw switching architectures. *Ar_ST_EXnica*, (15):15–24, April 2013. <http://www.guitex.org/home/it/arstexnica>.

Thank You!